



"At Entrypass, our ultimate goal is to return control to the end user. Combining state-of-the-art global technologies into one fully customizable platform, we deliver a better, more flexible and more integrated service. With our complete security system, you have the power to manage the security of your specific premises in your own specific way."

Founder

**KANE TEO**

Bridging  
The  
Gap



## TOTAL CONTROL IN YOUR HAND

Entrypass's mission is to constantly improve our systems with innovations to offer better control and flexibility to cater the needs of our customers. Our expertise is a result of our years of experience and spirit of delivering our best for our customers.



# THE ESSENCE OF ENTRYPASS

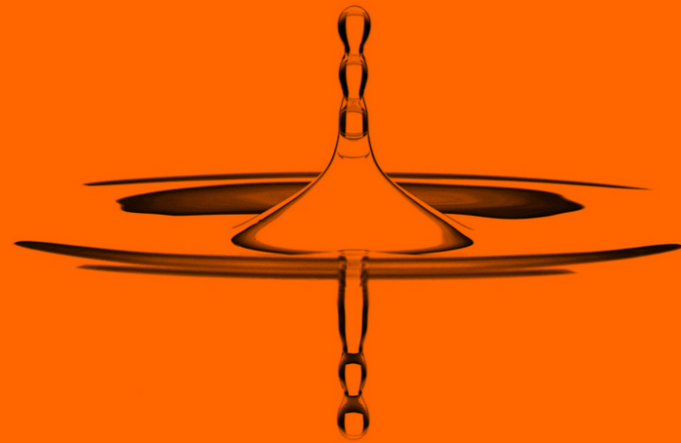

## Open platform

Our systems are engineered for compatibility and connectivity with various major security appliances as we constantly seek innovative solutions and advanced technologies for customized integration that allows freedom and total accessibility.



## Reliable

Safety is paramount when comes to security and we are committed to delivering quality systems on par with global standards that are easy to moderate while offering total flexibility to suit your specific needs.



## Innovative

Our expertise in technology innovation keeps us at the forefront of smart technological advances and interactive cyber capabilities that aim to keep you protected and aware wherever you are.



## Artificial intelligence

Our systems and solutions incorporate the latest Artificial Intelligence (AI) technologies which has and is rapidly becoming an important and integral part of the new age commercial world and community.



## Elegant

Our range of product feature attractive designs that are pleasing to the eye, flexible and offer ease of control at your fingertips.



## OUR SOLUTIONS

Entrypass works with industry-leading security systems suppliers and AI to integrate and validate combined solution to our customers. Entrusted by our technology partners to maximize the capabilities of their creations, we have built a track record of making scalable and expandable solutions possible for end-users, giving them the last say on what works for them.

# SYSTEM ARCHITECTURE DIAGRAM

## Management Office/Server Room

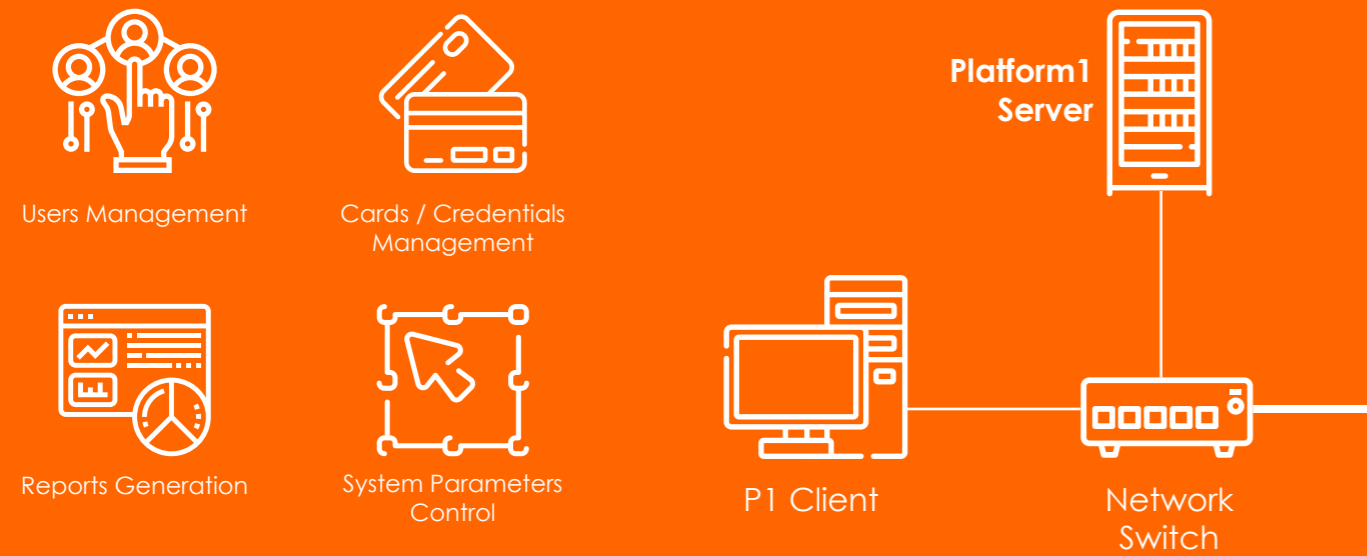

## Guard House

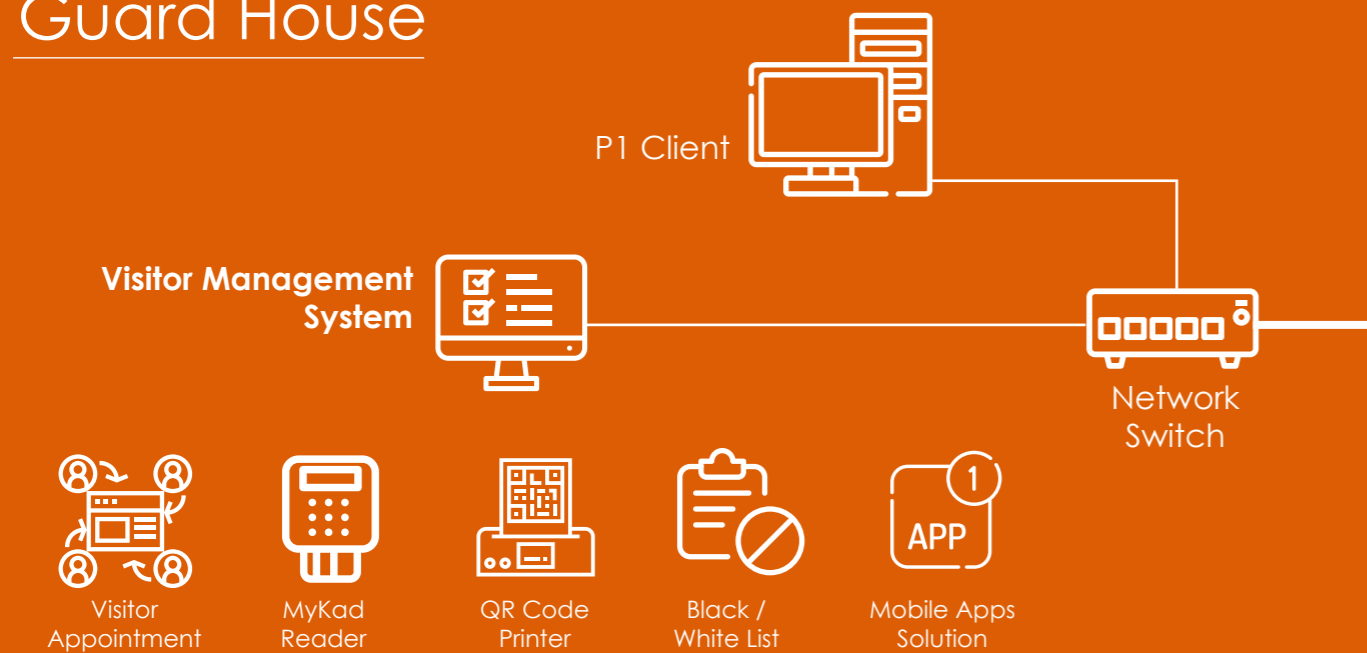

## Other Available Third Party Integration



## Building Security System

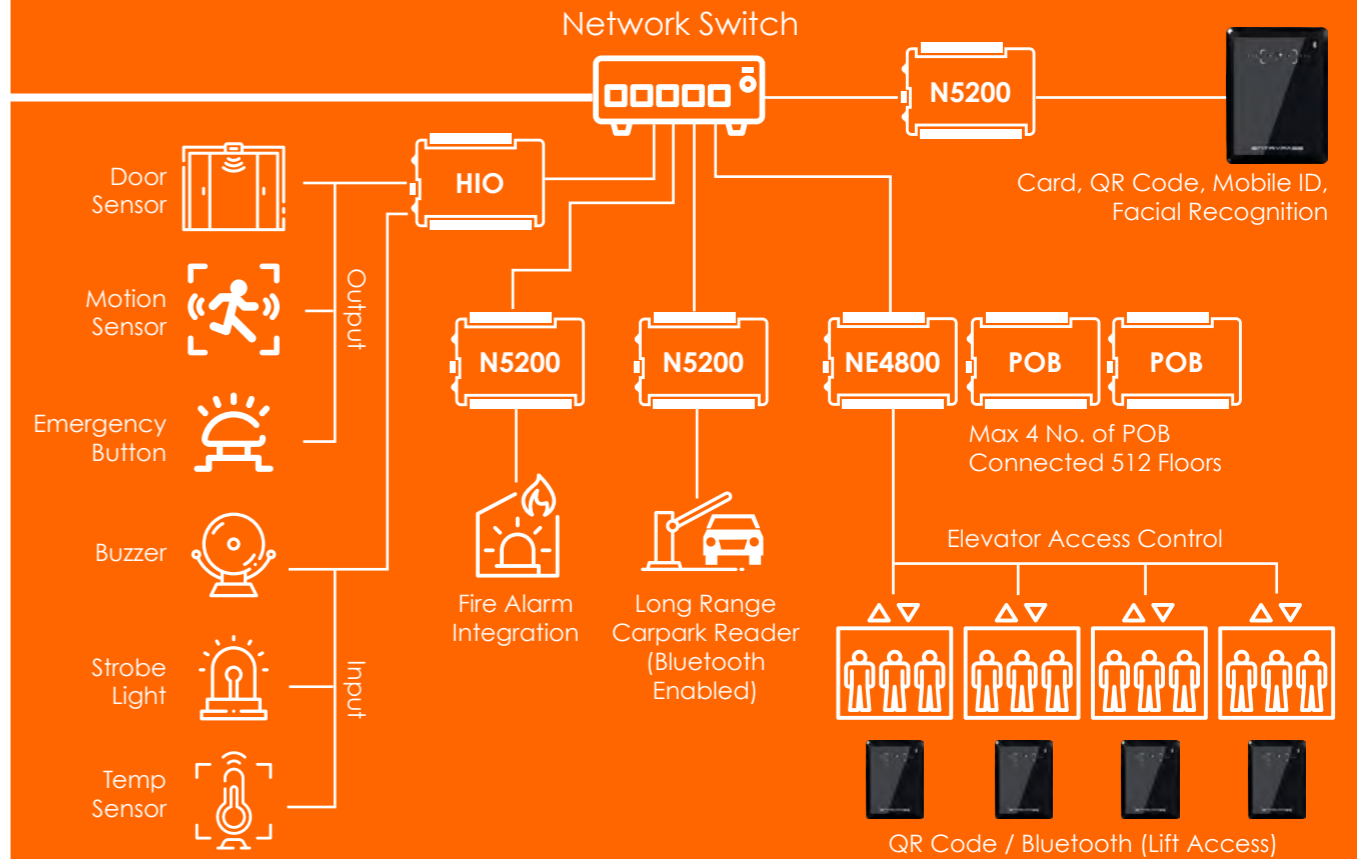

## CCTV Integration

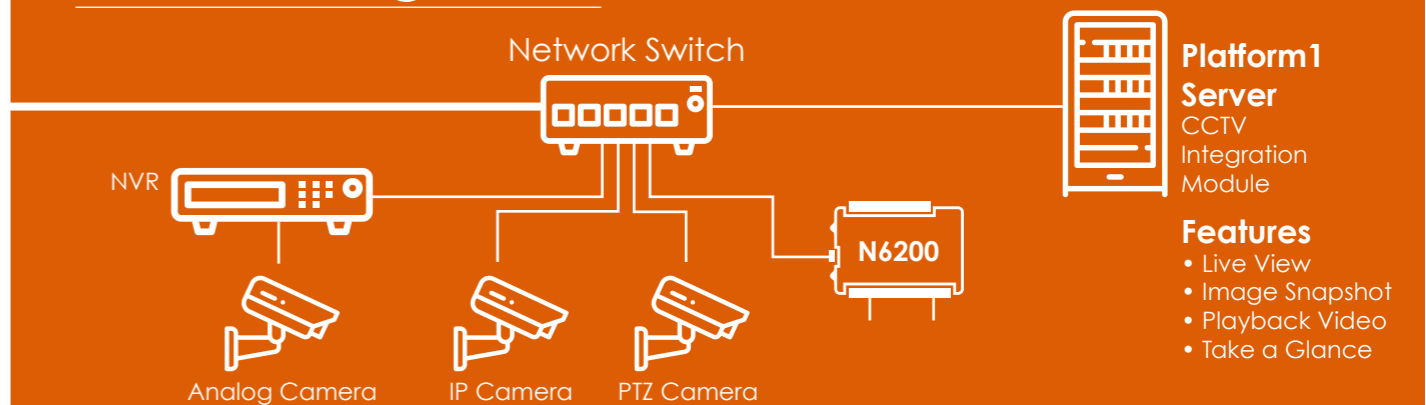

## Remote Access



TCP/IP

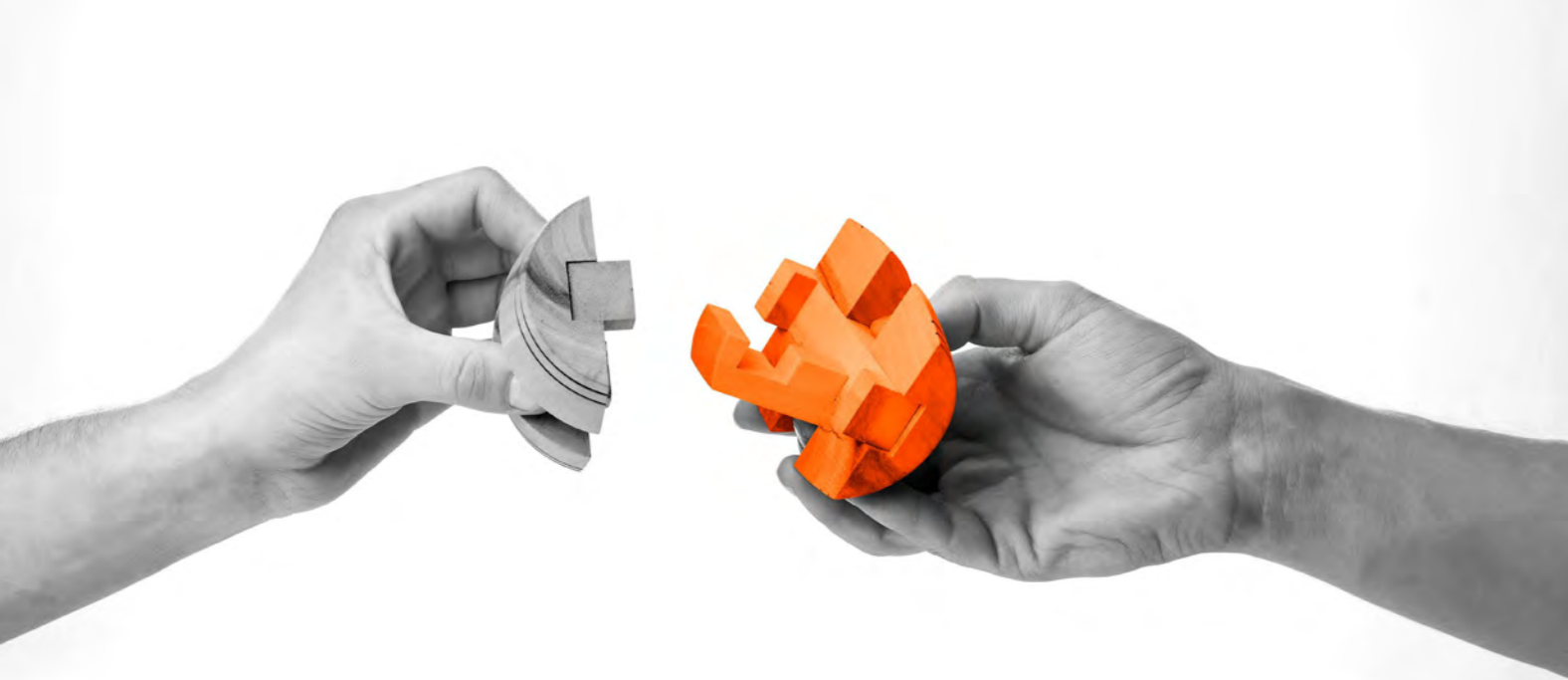

## OUR KEY PARTNERS

Dedicated to present our clients with the best possible unified solutions in security, we at EntryPass have forged professional and exclusive distributorships with many of our global partners and world-renown security component suppliers to ensure our clients receive uncompromised integrated solutions that excel. Entrusted by our partners to maximize the capabilities of their creations, we have built a track record of making scalable and expandable solutions possible for end-users, giving them the last say on what works for them.

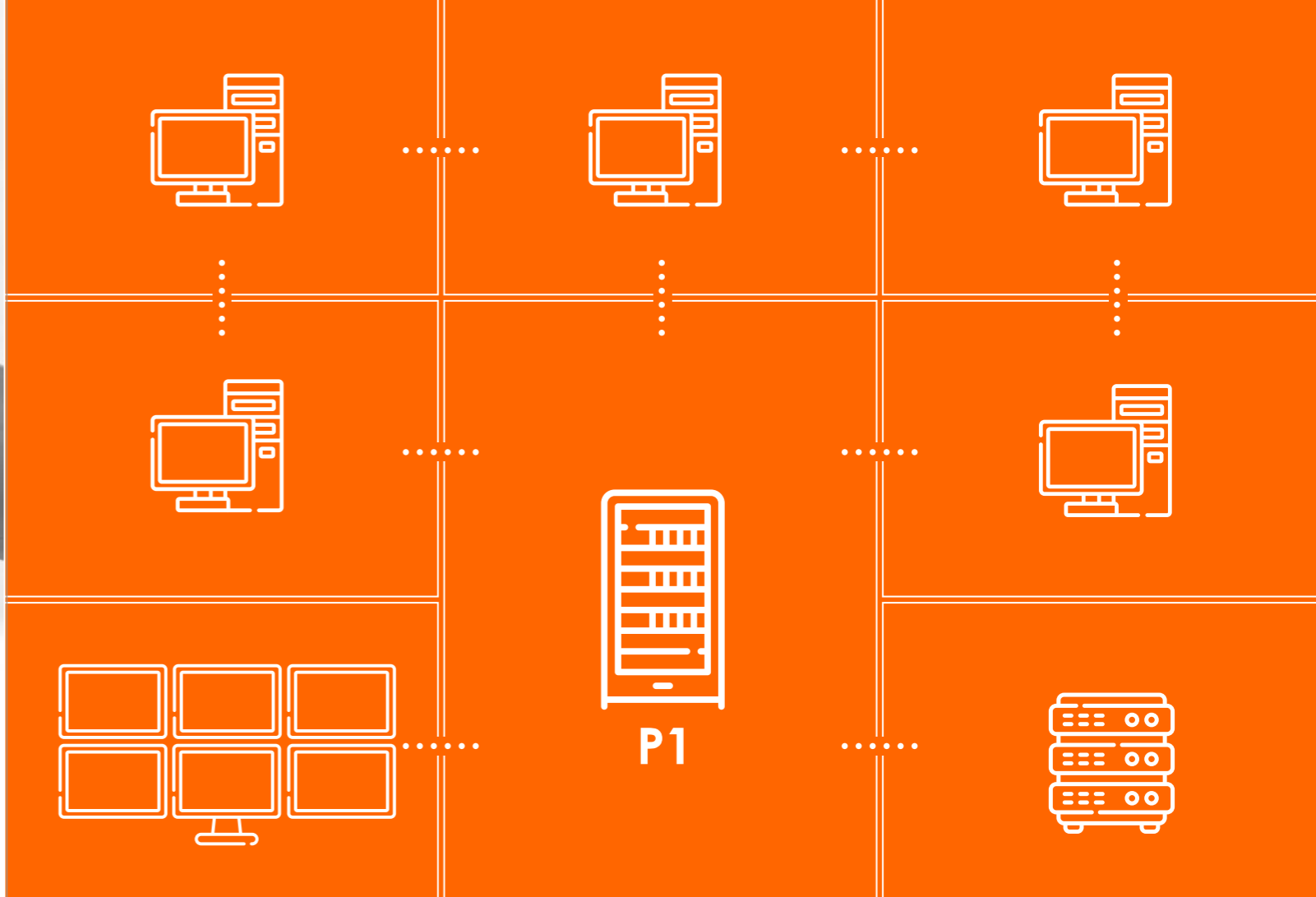

## PLATFORM1 SOFTWARE

The Entrypass Platform1 is an Access Control System developed to enhance scalability while providing the freedom to limit or extend its scalability reach. Designed as a client server-based Windows application, the Platform 1 is powerful and provides many integrated features, making it easily adaptable to today's most demanding physical access control structures.

The system uses client server architecture based on industry standard operating systems, networks and protocols to form a total integrated system that is capable of supporting a small implementation of a few doors, to a large scale, multi-locations that is made up of thousands of doors in an orderly distributed manner. Ultimately, you have the power to control and reset these configurations as your company evolves.

Modules

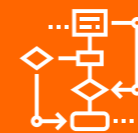

Redundancy Module



Multi Tenancy Module



CCTV Integration Module (CIM)



Elevator Integration Module (EIM)



  
Drag & Drop  
Operation Environment

  
Automated Pop-Up  
Video Stripe

  
PTZ Control

  
Event View Pane

  
Hierarchy Device  
Listing

  
Interactive Floor  
Plan

  
Transaction Searching

  
Take-A-Glance Live  
Video Playback

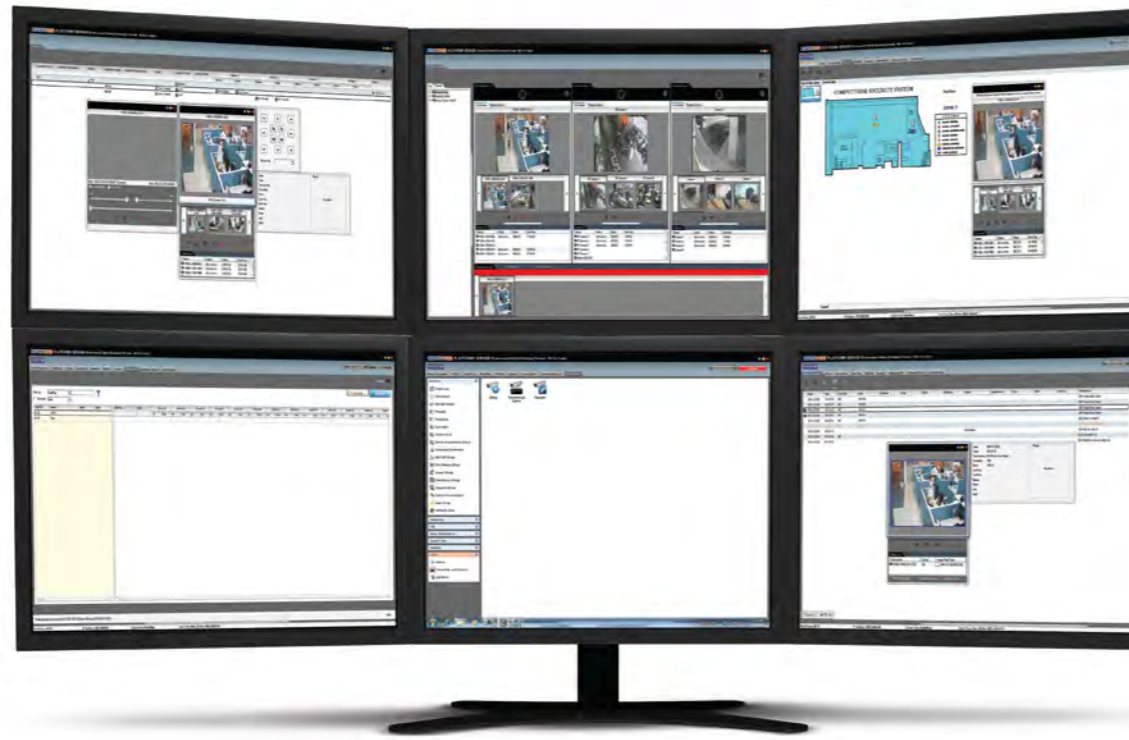

## EP.CIM CCTV Integration Module

Entrypass Platform 1 CCTV Integration Module (CIM) is designed to tackle and enhance the capabilities of the visual inadequate text-based physical access control system. Leveraging the visual data from CCTV system, it is able to provide verification to all event types - benefiting from its integration visually.

The CIM exhibits a framework of monitoring functionalities that is fully event driven, using real time physical access control event occurred within deployment as event marker (valid card entry, invalid card entry, door forced opened, door left opened and many more) to trigger a series of integrated events that enables the operator to quickly locate the event related data within the CCTV system deployed locally or remotely for visual verification purposes – saving you precious time and giving you total control over your next course of action, right there and then.

System Diagram

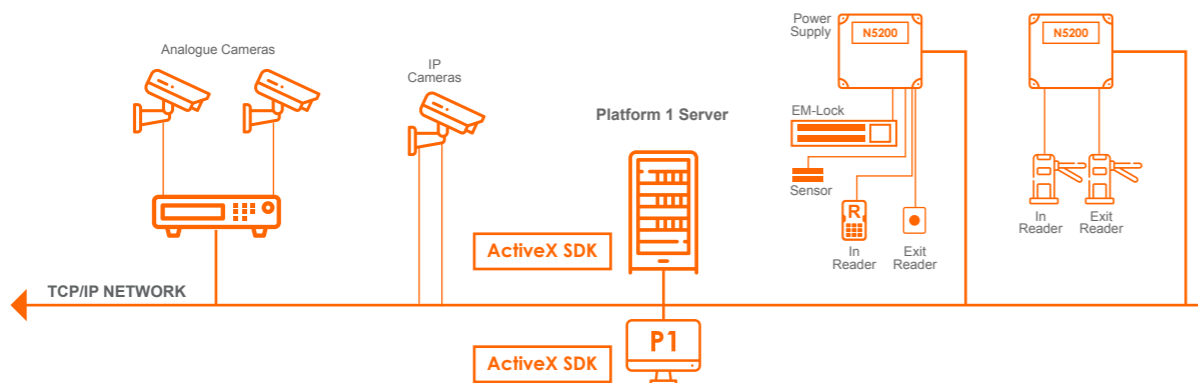

## EP.EIM Elevator Integration Module

Entrypass Platform1 High Level Lift Integration is smart elevator tailored solution for elevator system manufacturers to provide state-of-the-art elevator access control functionality. The communication backbone between Entrypass Platform1 High Level Elevator Integration and Elevator Systems manufacturer can be tailored by utilizing major communication protocols like Serial and TCP/IP based systems.



### Shorter travelling time

Respond to passengers' request to travel to a particular floor using multi-elevator installations, which separate them into smaller groups first before assigning them to designated elevator cars, thereby reducing waiting and travel time.



### Reduce queue time at peak hours

Reducing the overall queue time from the moment a visitor / tenant enters the building to reaching their destination.



### Contribute to passenger comfort

Depending on level of service requirements by building owners, timely call requests will be sent from TCR and HCR to elevator control system so that the elevator control system can determine the optimum number of passenger in an elevator car to prevent overcrowding.



### Integrated access control

Proper visitor / tenant access control can be implemented within a building where elevators will only stop at floor(s) they are authorised to access, ensuring only trusted person remains in an area.

Supported Elevator Brand :



# ENTRYPASS PLATFORM 1

## Server Redundancy Module

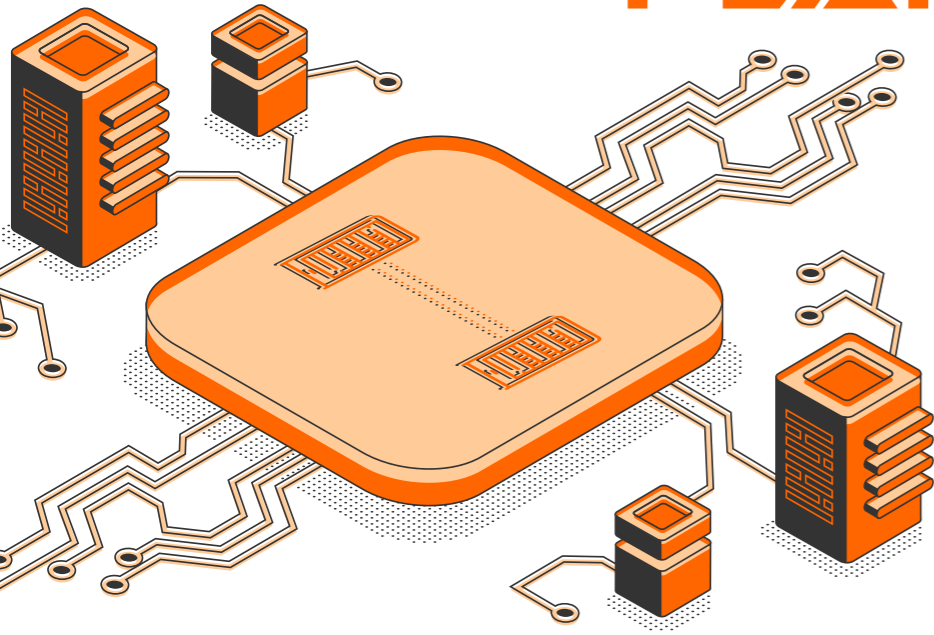

Redundancy is a module within Entrypass Platform1 Server which is designed as an active resource duplication service that will allow two separate Entrypass Platform1 Server systems to monitor each other's uptime status and to intervene by taking over the system operation whenever the 'active' server is not in operation. This module is very much applicable for mission critical operations that demand uninterrupted stability within a premise.



### High system availability

In the event of computer failure or system maintenance, operation interruption can be minimised. When primary server fail, a secondary server will take over and all functional operation of the primary server can be performed at secondary server.

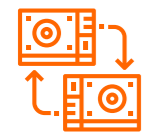

### Data redundancy

Data stored at primary server will be replicated to the secondary server and vice versa. This ensures that same piece of data exists in both primary and secondary server. In this way, if data at primary server is lost or corrupted, there is another copy of data available at secondary server.



### Data loss prevention (fail over)

If downtime of primary server is long, data stored in controllers may be overwritten. With this module, when the primary server fails, controllers will begin to transmit data to secondary server. This prevent data got overwritten at the controllers and thus prevent loss of data.



### System Architecture

Architecture wise, primary server will be termed as Active Server, whereas secondary server as Standby Server.

### System Diagram

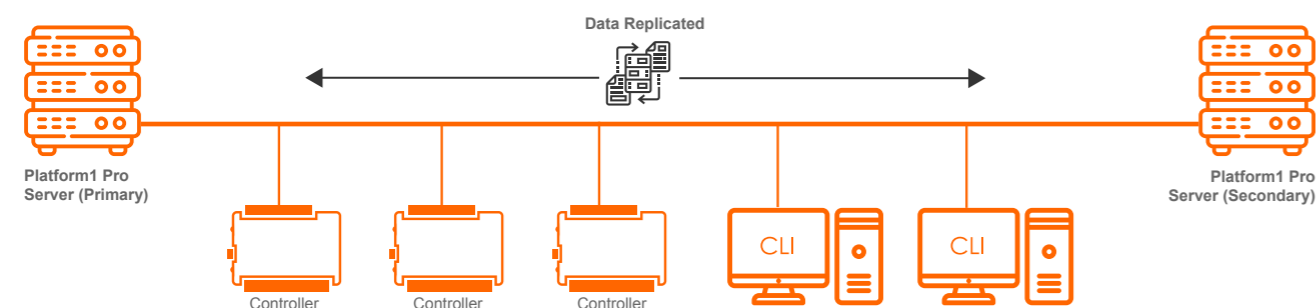

# ENTRYPASS PLATFORM 1

## Multi-tenancy Module

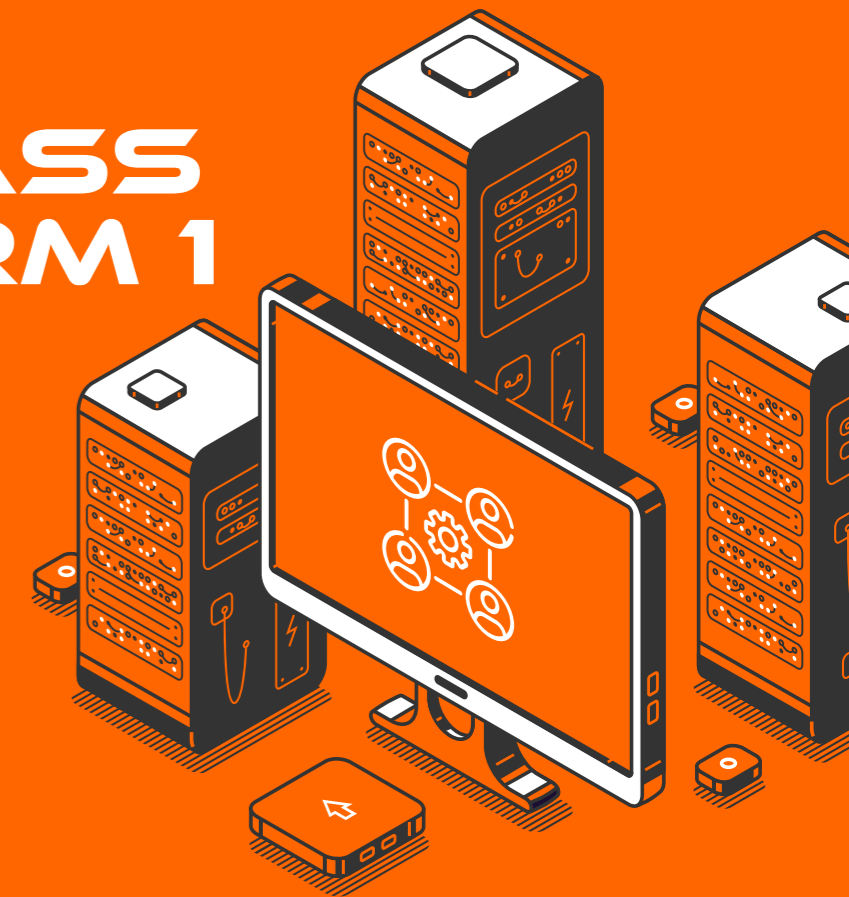

Entrpass P1 Multi-Tenancy (Cluster) is a module that is built into Entrypass Platform1 Server to cater for multi user environment with the capability of creating user specific sets of data which is attributable to that particular user only.



### User Segregation & Decentralised System Management

User control and database is distinct from one cluster to another. Each clustered system will only be able to view data, perform system management and generate reports for their own clusters only. This will allow decentralised system management where clustered users will be able to manage and configure access control related settings without system administrators.



### Personalised configuration

Despite Entrypass Platform1 Server is only a single system installed in a server, it has the capability to allow different clustered users to perform different settings while those settings are specific to their cluster.

### Feature Highlights

#### Cluster specific data

When a cluster is created, all data are cluster specific and attributable to that specific cluster.

#### Cluster specific controls

Within each cluster, clustered users will be able to perform configuration on objects like Access Group, Access Level, Department, Fire Release Group, Global Antipassback Group, Interlocking Group, Job, Map, Menu Control, Roll Call Group, Roster, Shift, Time Set and Time Zone.

#### Clustered Reporting

Clustered user will be able to generate report related to their own cluster.

### System Diagram

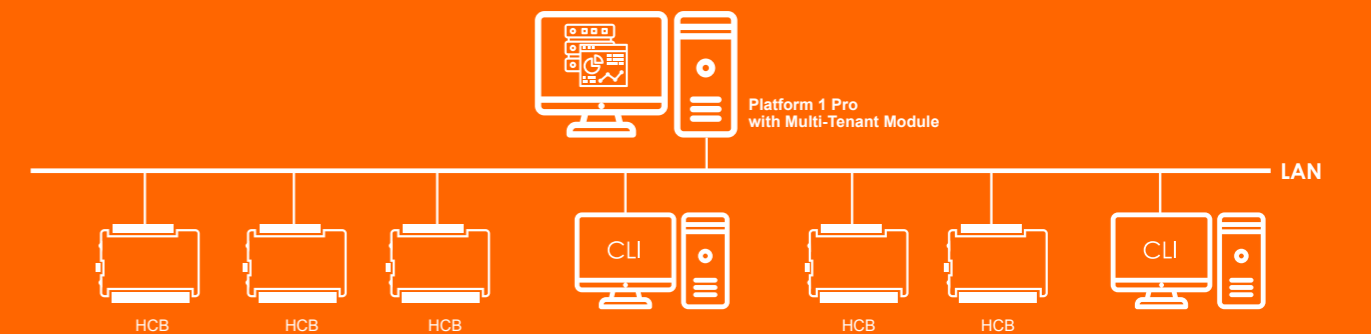

### Cluster Assignment











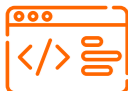





Everytime system administrators perform an activity of creating a new object (features & settings), the system will prompt the system administrator to assign which cluster that the new object should belong to, so as to enable the system to uniquely identify that object and all its subsequent transaction / data(s) with an identifier.



# PROFESSIONALIZE YOUR VISITOR MANAGEMENT SYSTEM SOLUTION

## EP.VMS P1 Professional Add-on Module

Entrypass Visitor Management System (VMS) gives our user the capability to register a visitor as they enter and exit the premises. Enhanced with the latest web technologies (full web application that only requires Internet browser to operate), VMS gives our users to improve on the way you welcome your visitors into the premise by streamlining the process for visitor check-in – making it convenient for both sides.

 Web based application	 Host notification upon visitor overstay did not checkout	 Operator dashboard for real time visitor status	 Visitor category listing
 Integratable with Entrypass Platform1 Access Control System	 Whitelist and Blacklist	 Comprehensive reporting engine	 Encrypted database
 Host quick search	 Automatic database backup to local or remote host	 Pre-Scheduling for visit	 Searchable visitor history
 Export report to various format (csv/pdf)	 Self expiring visitor badges (RFID card)	 Mykad reader integration	 Emergency evacuation report

### System Workflow

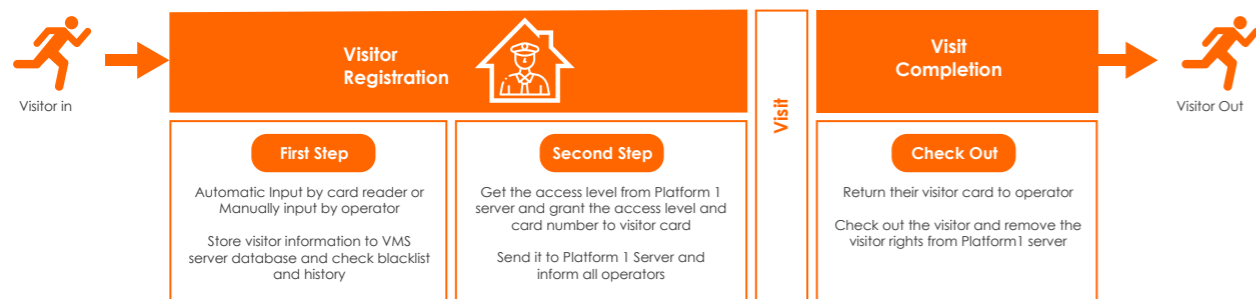

# EP.CLOUD.VMS

Entrypass Cloud Visitor Management System

Facilities and organisation are facing more security threats today than ever. A number of security breaches caused by the mismanaged entry of strangers within the premises of important buildings are reported every day.

Prioritisation and standardisation of visitor management comes down to necessity. Many companies, particularly enterprises, taking the visitor management system as a strategic tool critical to enhance security and operations. A tool that is necessary to protect people, data and infrastructure. A sophisticated platform that could oversee multiple sites in various locations, and able to integrate with Entrypass access control system and provide a level of visitor visibility unseen on sites before.

The efficiency, security and personalisation of a visitor management system create a positive visitor experience from the beginning to the end. Visitor management system protects your workplace from potential security threats by requiring digital registration to many and not limited to following activities: -



- Business meetings
- Contractors and vendors visits
- Candidates for interview
- Courier delivery personnel
- Unexpected drop-ins etc

 Cloud based Visitor Management System (VMS)	 Pre-registration that support facial enrolment with health declaration form	 Dashboard status monitoring	 Convenient and seamless integration
 Support multi-tenant application	 Support hybrid architecture for both cloud and on premises.	 Automated visitor registration workflow	 Comprehensive report generation
 Support unlimited host & visitor registration			

### Cloud Visitor Management System Workflow





# FULLY INTEGRATION ACCESS CARD PRINTING SOLUTION



## EP.PRINTID P1 Professional Add-on Module

Entrypass PrintID is the ideal choice of card printing software that fits most requirements of any organizations. PrintID offers a series of features that improves on the card printing, issuance, and management in one go.

With full integration with Entrypass Platform 1 Server, PrintID has full access to the cardholder's database right at the operator's fingertips. Acquiring data for printing is no longer a hassle while speeding up entire card design and data entry processes.

Featured in PrintID is an advanced and intuitive card design user interface that allows the creation of professional ID card quickly and easily. Furthermore, it features an inbuilt template system that gives the ability of fully customizing the card design. Should the template need to differ from department to department, even from person to person, PrintID allows the perfect design to be created for every situation.

Collapsible Panel View	Priority Print	Print Job Report	Selectable Print List	Single/double Sided* Print
2-point Cropping Feature	Single/batch Print	Drawing Shape Creation	Stored Print List	Multiple Template Print
Customizable Template Design	Firebird Database Support	UV Image/text Printing (Printer Specific)	Predefined/user Defined Printing Field	

### System Diagram

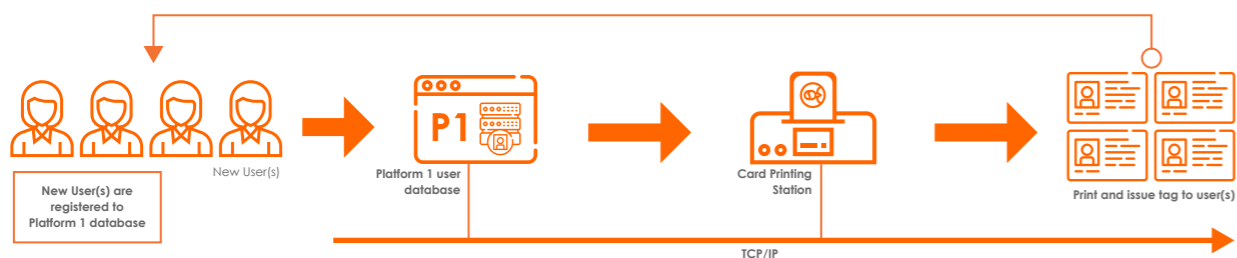

\*Remark : EP.PRINTID Module only available for Fargo Printers at the moment.



# Entrypass AI IoT Video Management Platform



CLOUD



DESKTOP



SERVER



MOBILE

## IP Video Made Simple

EVMP began as an idea born of necessity – there simply had to be a better way to discover, view, record, manage, and augment IP video cameras.

### EVMP Core Philosophies

<p> <b>Instantly Usable</b> Powerful and feature rich and require no training to install, configure, and use at an advanced level.</p> <p><b>2 Minute Installation</b> • ~120 MB installation package • No prerequisite software required</p> <p><b>1.5 Million Cameras</b> • Tens of thousands of installed systems • ~10 support tickets a day</p> <p><b>100+ Countries</b> • 20 supported languages</p>	<p> <b>Cross-Platform &amp; Lightweight</b> Compatible with the world's most commonly used Operating Systems and Devices out of the box.</p> <p><b>OS's and Devices</b> </p> <p><b>99% of IP Cameras</b> • 300+ Manufacturers • Thousands of IP Video Devices</p> <p><b>Nvidia Devices</b> • Jetson / Xavier • Tesla</p>	<p> <b>Developer Friendly &amp; Extensible</b> Solve the core challenges of IP video management and allow developers to customize for their specific use cases.</p> <p><b>Vertical Solutions</b></p> <ul style="list-style-type: none"> <li>• Security Surveillance</li> <li>• Production Monitoring</li> <li>• Hazardous Testing</li> <li>• Retail Analytics</li> <li>• Wildlife Research</li> <li>• Mass Transit</li> <li>• Autonomous Robotics</li> <li>• Defense Training</li> <li>• Safe City</li> <li>• Streaming video from cars in space</li> </ul>
--	--	---



# SMART CANOPY



Smart Canopy is an information aggregator. We collect events.



Smart Canopy is a real-time framework. We push real-time event notifications. We also have dashboards to display real-time events.



Smart Canopy takes action. We can take actions when an event occurs.



## High Performance

High performance multi-core event handling module



## Dynamic Response Planning

Automated case creation based on standard operating procedures



## Real Time Incident

Timely event & Information handling with great efficiency



## Advanced Notification

Automated notification dispatch to variety destination & devices



## Operation Dashboard

Comprehensive metrics for event, active alert, open cases, system resources to enhance manageability

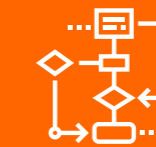

## Integration Friendly

Modular in design, easy integration with any 3rd party system via API framework

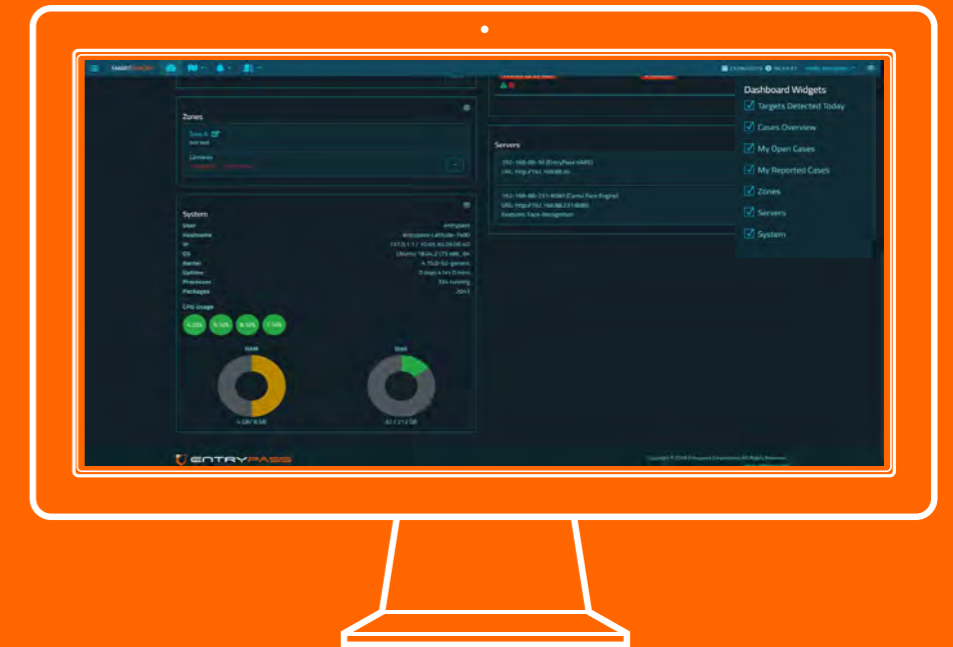
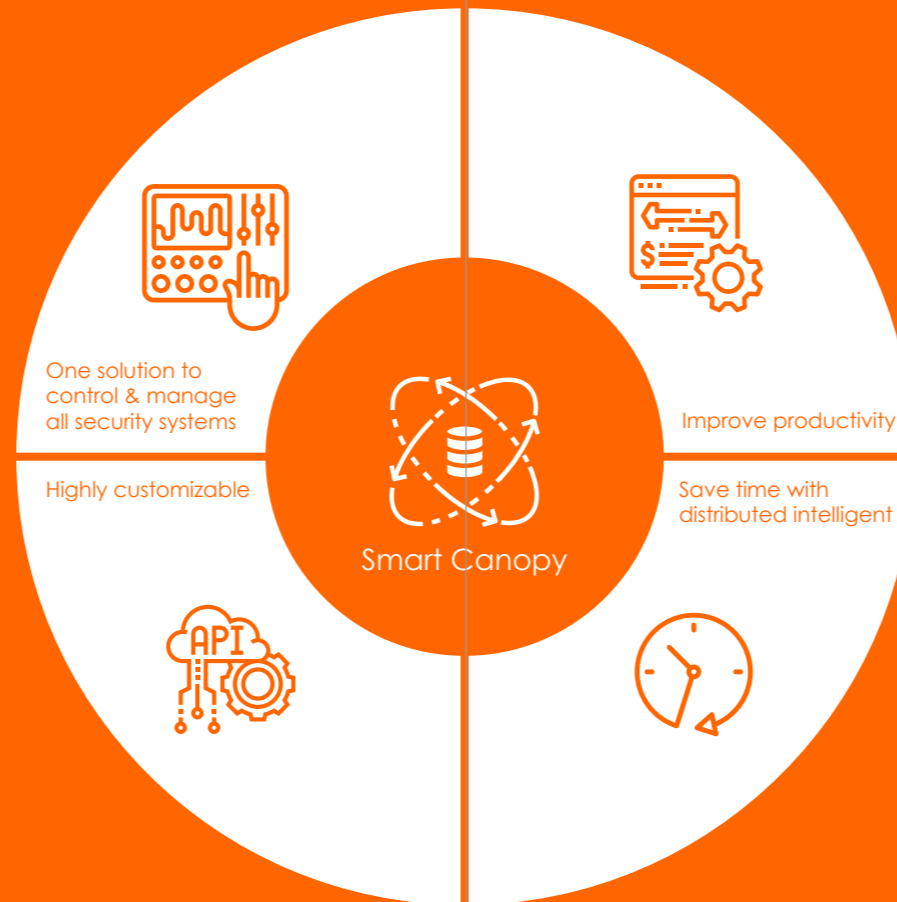
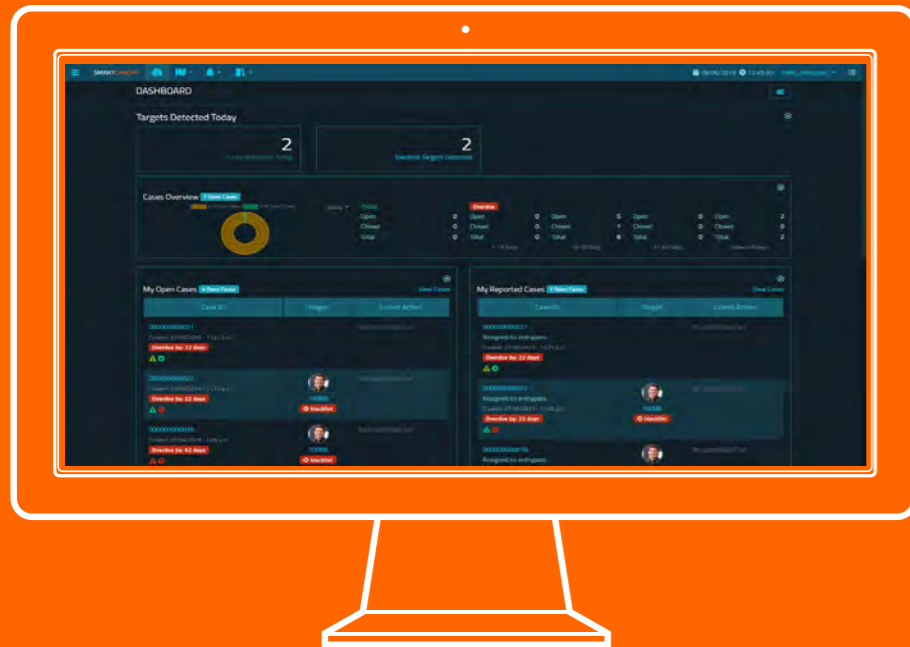

# OUR PRODUCT

Entrypass manufactures a series of products that centralizes on various functions and needs. From Platform Software and CCTV Integration Modules, to Active Networks, Serial Communicators and Elevator Control Panels; our products are future-friendly and are made to give the end-users the power to moderate and configure their security systems almost instantaneously. We at Entrypass have conducted sufficient researches and tests to ensure what we have to offer are of the best grade and delivers exceptional performance like no other.

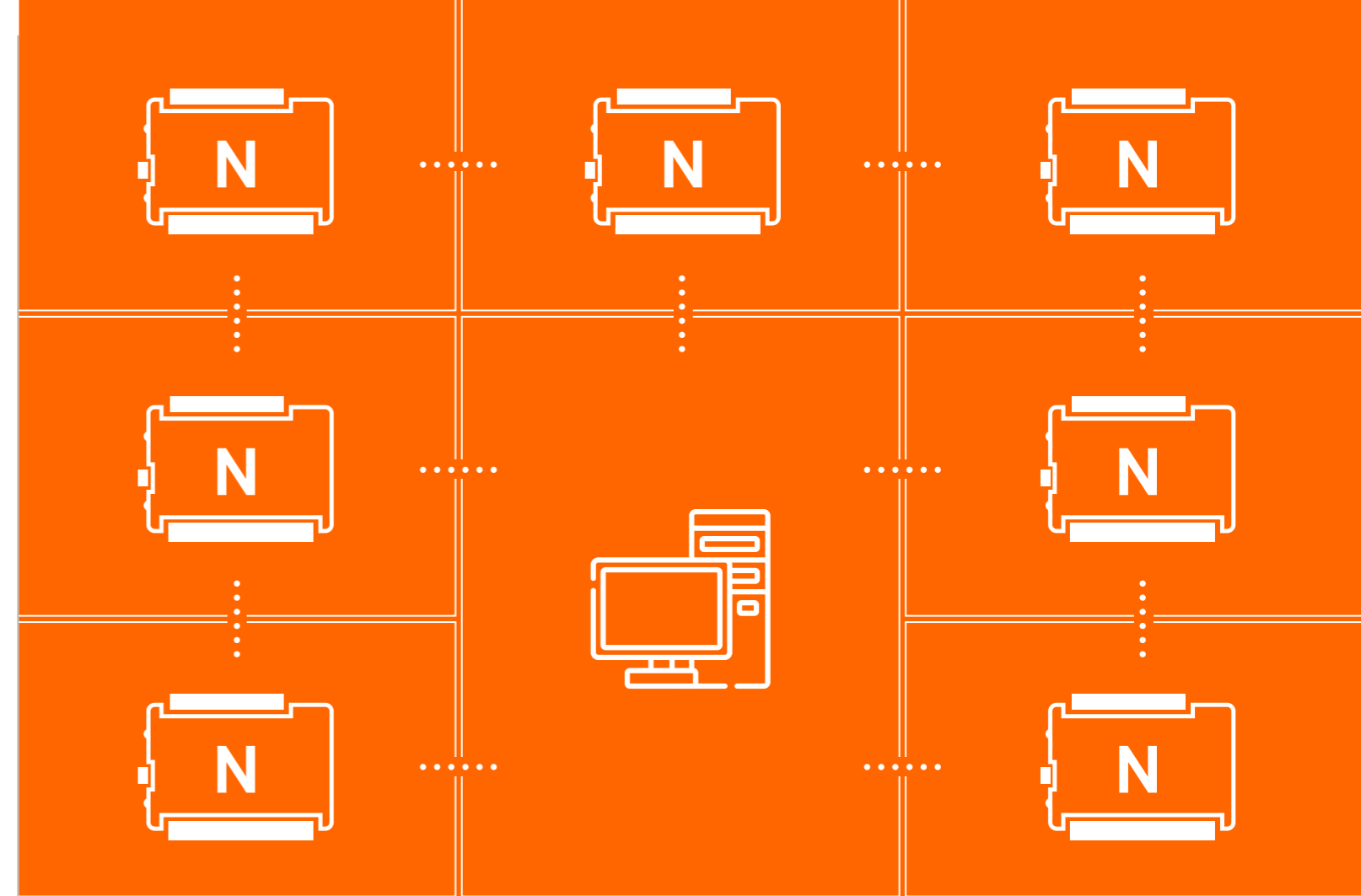
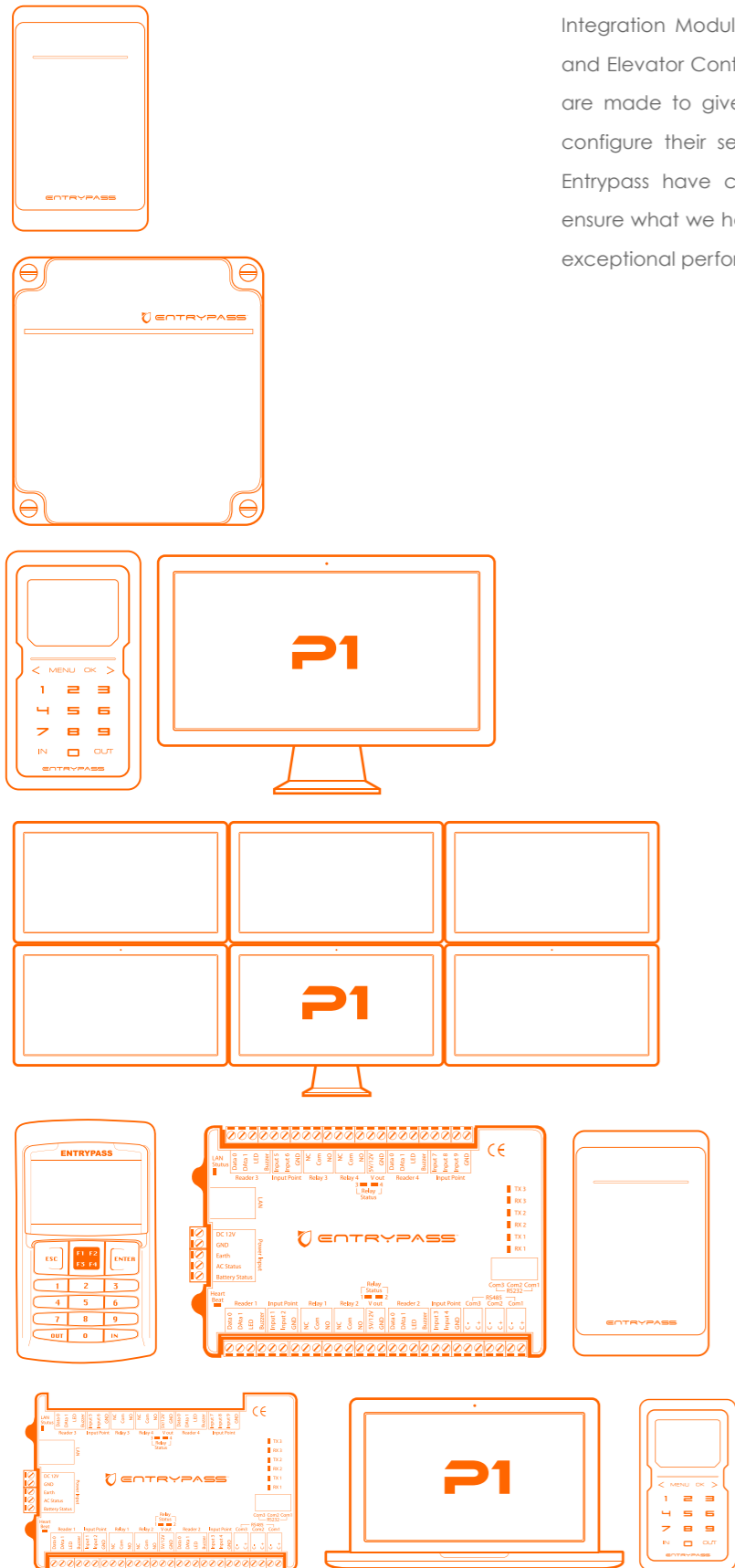

## ACTIVE NETWORK

Entrypass Active Networks are designed to enhance highly customized and rapid 'real-time' changes to the underlying network operation. Brilliantly engineered with all the power you need to enable code-sending, minus the unnecessary buffer time with its distributed architecture capable of processing access demand at the edge level without leveraging at the server end.

### N-MINI 2 Integrated Network Controller



- Dynamic Storage Allocation (DSA)
- Active Event Transmission
- Customisable Logo Display
- Door Interlocking \*
- Firmware Upgrade Over Ethernet
- Dual Operation Mode (DOM)
- Peer-To-Peer Global Antipassback
- Reader Output Control
- Configurable Input
- Active Diagnostic Capability
- Secured Network Connectivity
- Built-In Web Configuration Page
- AES 128 Bit Encryption
- Event Based Triggering (EBT) \*\*



# N6400

## Active Network Control Panel

20 Digits (Structure Ready) Easylink / SSID Ready  
 Support 100,000 Users And 200,000 Events Memory  
 Support Single Doors / 2 Doors / 4-In doors  
 Support Car Park Mode  
 Support Dynamic Reader Location  
 Compatible with Various Reader Technologies  
 ActiveTransmit & ActiveDownload  
 Peer To Peer Global Anti-Passback  
 Configurable Digital / Supervised Inputs (8)  
 Unlimited Access Level  
 Onboard & Cross-Board Interlocking  
 User Counting (Card Holder / Car Park)  
 Advance Encryption Standard (AES)  
 Reader Output Control  
 Dynamic Storage Allocation  
 Dynamic Operation Profile  
 Event Based Triggering (EBT)

# N6200

## Active Network Control Panel

20 Digits (Structure Ready) Easylink / SSID Ready  
 Support 100,000 Users And 200,000 Events Memory  
 Support Single Doors / 2 Doors  
 Support Car Park Mode  
 Support Dynamic Reader Location  
 Compatible with Various Reader Technologies  
 ActiveTransmit & ActiveDownload  
 Peer To Peer Global Anti-Passback  
 Configurable Digital / Supervised Inputs (8)  
 Unlimited Access Level  
 Onboard & Cross-Board Interlocking  
 User Counting (Card Holder / Car Park)  
 Advance Encryption Standard (AES)  
 Reader Output Control  
 Dynamic Storage Allocation  
 Dynamic Operation Profile  
 Event Based Triggering (EBT)

# N5400

## Active Network Control Panel

Support Single Doors / 2 Doors / 4-In doors  
 Support Dynamic Reader Location  
 Support Car Park Mode  
 Compatible with various reader technologies  
 ActiveTransmit & ActiveDownload  
 Peer To Peer Global Anti-Passback  
 Configurable Digital / Supervised inputs (8)  
 Unlimited Access Level  
 Onboard & Cross-Board Interlocking  
 User Counting (Card Holder / Car Park)  
 Reader Output Control  
 Dynamic Storage Allocation  
 Support 30,000 Users And 80,000 Event Memory

# N5200

## Active Network Control Panel

Support Single / 2-In doors  
 Support Car Park Mode  
 Support Dynamic Reader Location  
 Compatible with various reader technologies  
 ActiveTransmit & ActiveDownload  
 Peer To Peer Global Anti-Passback  
 Configurable Digital / Supervised inputs (8)  
 Unlimited Access Level  
 Onboard & Cross-Board Interlocking  
 User Counting (Card Holder / Car Park)  
 Reader Output Control  
 Dynamic Storage Allocation  
 Support 30,000 Users And 80,000 Event Memory

# N5150

## Active Network Control Panel

Support Single / 2-In doors  
 Support Car Park Mode  
 Compatible with various reader technologies  
 ActiveTransmit & ActiveDownload  
 Peer To Peer Global Anti-Passback  
 Configurable Digital / Supervised inputs (4)  
 Quick Terminal Plug-in Connectors  
 Firmware Upgrade via Server  
 Reader Output Control  
 Onboard & Cross-Board Door Interlocking  
 Support 5,000 Users And 10,000 Event Memory

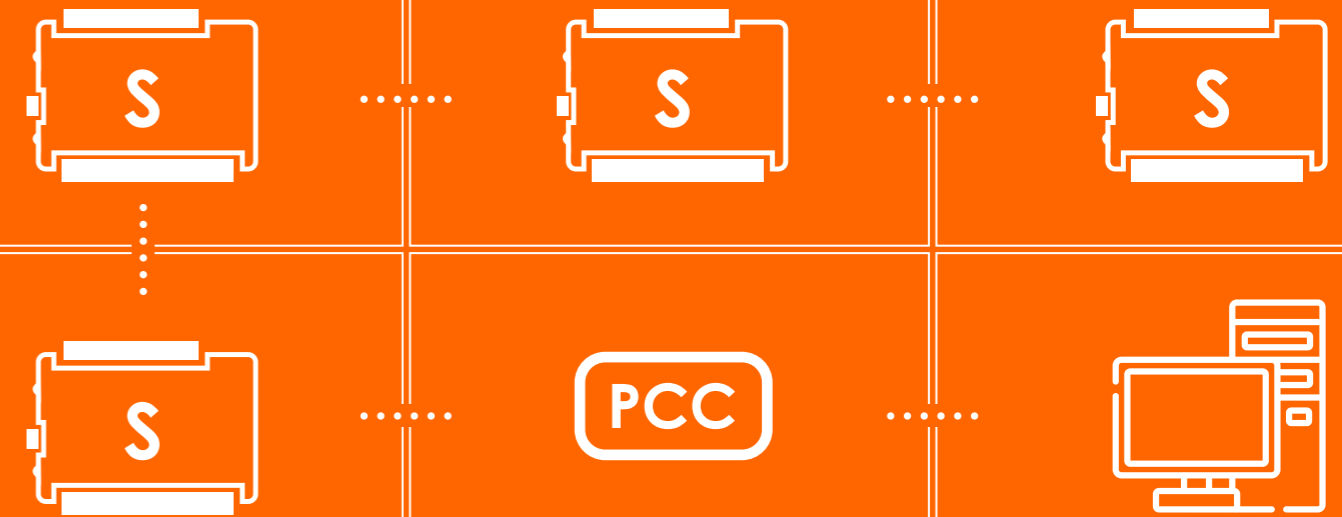
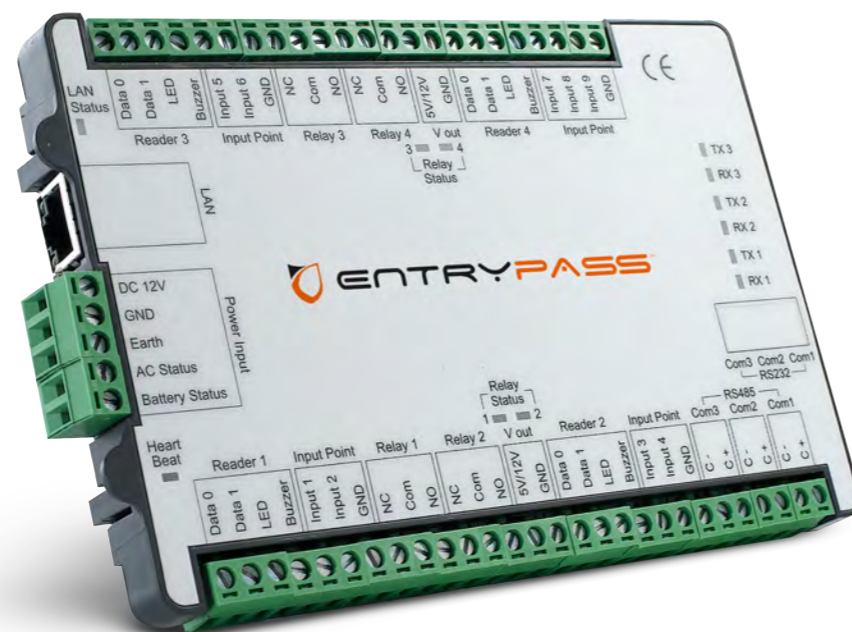

# SERIAL COMMUNICATION

Still an important and relevant system today, Entrypass Serial Communicators enables transmission of information between computers or between computers and peripheral devices, one bit at a time over a single line, either synchronous or asynchronous. Our range of Serial Communication devices varies from integrated controllers with built-in readers to advanced 4 readers control panel and even hybrid input/output control panels to suit your specific needs and requirements.

# S3400

## Serial Communication Control Panel

Support Single Doors / 2 Doors / 4-In doors  
 Support Car Park Mode  
 Support Dynamic Reader Location  
 Compatible with various reader technologies  
 Dynamic Storage Allocation  
 Dynamic Operation Profile  
 Mixed Profile Operation  
 Event Based Triggering  
 Support Future Add-On Module  
 User Counting (Card Holder / Car Park)  
 Support 30,000 Users And 80,000 Event Memory

# S3200

## Serial Communication Control Panel

Support Single / 2-In doors  
 Support Car Park Mode  
 Compatible with various reader technologies  
 Dynamic Storage Allocation  
 Dynamic Operation Profile  
 Mixed Profile Operation  
 Event Based Triggering  
 Support Future Add-On Module  
 User Counting (Card Holder / Car Park)  
 Support 30,000 Users And 80,000 Event Memory

# S3150

## Serial Communication Control Panel

Support Single / 2-In doors  
 Support Car Park Mode  
 Compatible with various reader technologies  
 RS-485 / RS-232 communication ports  
 Configurable Digital / Supervised inputs (4)  
 Quick terminal plug-in connectors  
 Firmware upgrade via server  
 Reader Output Control  
 AC Fail Monitoring  
 Battery Monitoring  
 Support 5,000 Users And 10,000 Event Memory

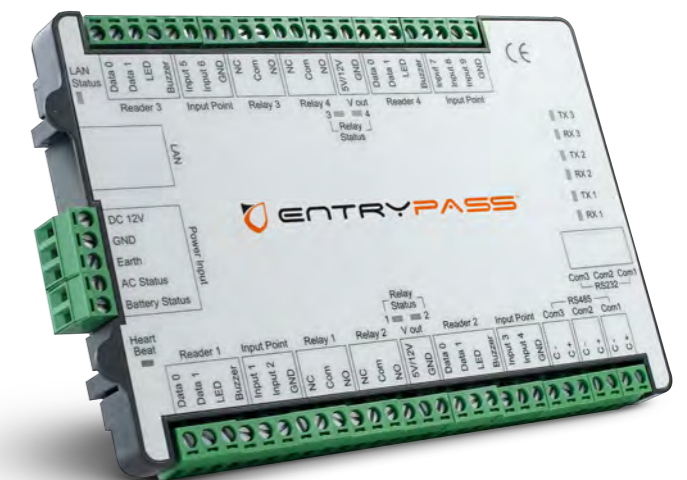



# NETWORK MULTI-ELEVATOR CONTROL PANEL

Entrypass Network Multi-Elevator control panel is specifically designed to increase security level of an elevator system built in high rise buildings such as condominium, apartment, or office building applications. Elevator Access Control system allows authorised users to gain access to designated elevator car and floors based on their user rights granted. User rights for elevator car & floor accessibility are configurable via Entrypass Platform 1 Server - Professional Edition.



## NE4800 Network Multi-Elevator Control Panel

- Support a maximum of 4 elevator cars, with each elevator serving up to 128 floors
- Support a maximum of 30,000 card holder, 80,000 event-transaction
- Support a maximum of 512 controllable floors
- Dynamic I/O Assignment (Reader / Output)
- Multiple Wiegand Group for various card formats
- 10 sets of Facility Code
- Support 128 bits AES Encryption for communication
- Adopted standard OSDP Protocol
- Flexible I/O Partitioning

Serial Communication Elevator Control Panel

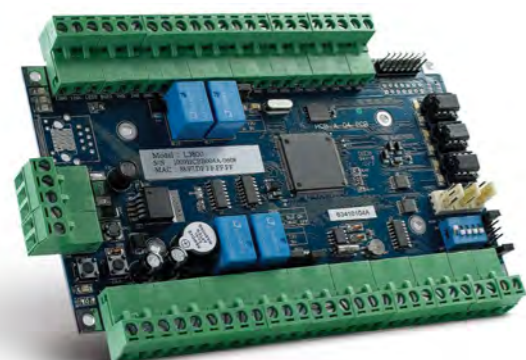

## L3800 Elevator Control Panel

- Support 8 floors by default (extendable to 136 Floors max.)
- Support timezone control bypass for individual floor
- Support up to 4 readers max.
- Support both RFID & biometrics readers
- Emergency bypass function by software
- Emergency bypass function by key Switch
- Support 30,000 Users And 80,000 Event Memory

## POB Passive Output Board

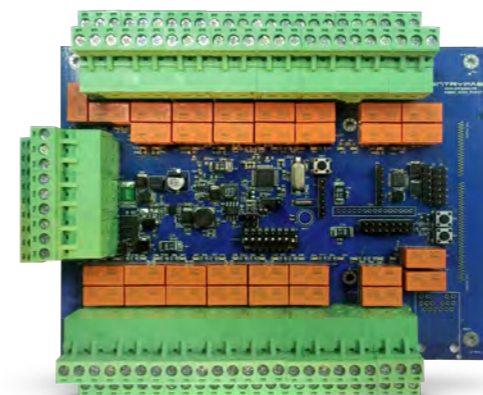

Specification	Description
MCU	STM32F072C8T6 Cortex M0 @ 48MHz
MCU RAM	64 KB
MCU ROM	16 KB
Operation Voltage	+12V
Max Current consumption @12V	3204I : TBA
Min Current consumption @12V	25 mA
Output type	Max 32 number of SPDT type Connections
Output connection spec	Please refer to NEC EC2-12NU relay datasheet
Input type	Max 32 number of supervised inputs
Input bias voltage	+12V
Communication ports	One Isolated and protected RS485, One CAN bus
Processing power extension	SODIMM 204 pin to support A20 core board

System Diagram - Four (4) Elevator Cabs with Single (1) Passive Output Boards

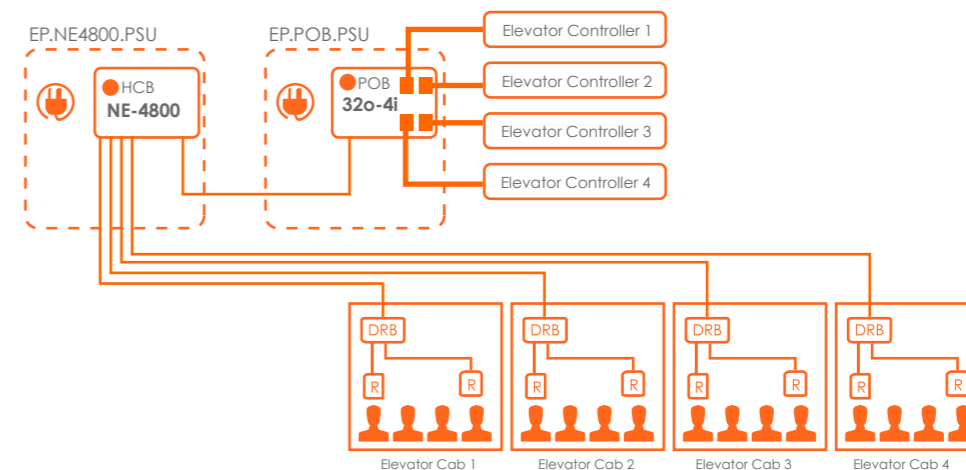

## HIO Hybrid Input Output Control Panel

- Support up to maximum of 16 inputs & 16 outputs
- Support dual mode communication (Modbus Serial & Modbus TCP/IP)
- Support both open and close trigger devices
- Support One-To-Many / Many-To-One / Many-To-Many configuration
- Support both toggle and alarm mode monitoring function
- Support various applications (Alarm / Lift)

System Diagram

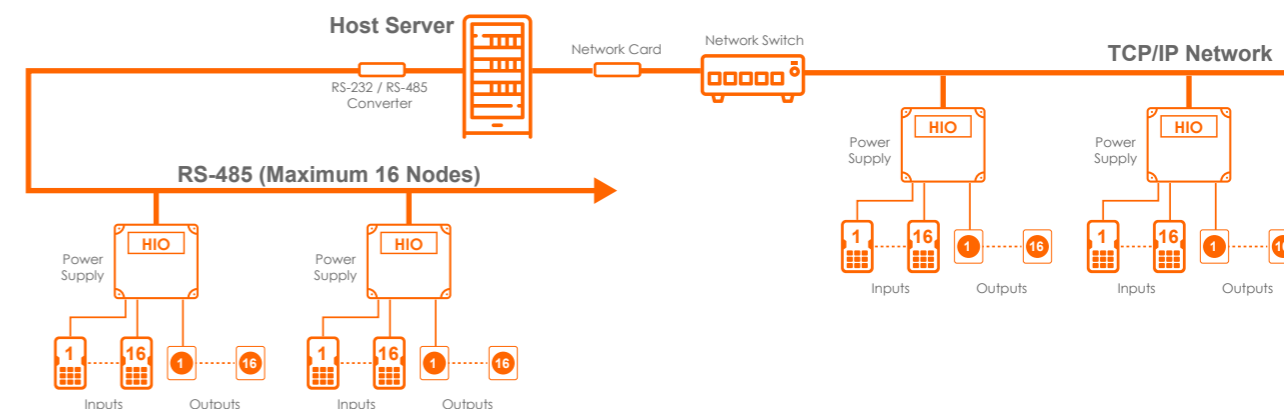



# SMART READER



\*Images shown may vary from actual products.

# SMART ID QR CODE READER

Entrypass QR Code Reader and Module



Picture shown is for illustration purposes only. Actual products may vary due to product enhancement.

  
Full LCD Display  
Touch Screen

  
Slimline Reader  
Interface

  
OSDP (Open Supervised  
Device Protocol)

  
MIFARE Sector  
Read & Write

  
Multi-protocols  
(runtime configurable)

  
AES 128  
Encryption

  
Full size antenna

  
IP65

  
Reader Status  
Monitoring

  
Support 14443A /  
14443B

Entrypass QR series consists of QR code reader and module that enables transformation of user experience in the access control and visitor management environment with more convenience, speed and security.



  
Mifare  
Desfire

Available with different technologies,  
QR code, Mifare & DesFire.

  
Economical mounts type

  
Easily seen under dark environment  
with back lit design

  
Tamper protection

  
Support on-site Reader Configuration Card  
to change certain parameters



# EP.BSR EP.BSKR

Bluetooth Multi-technologies  
Reader



# EP.SR102 EP.SRK102

DesFire EV1 / EV2 Reader

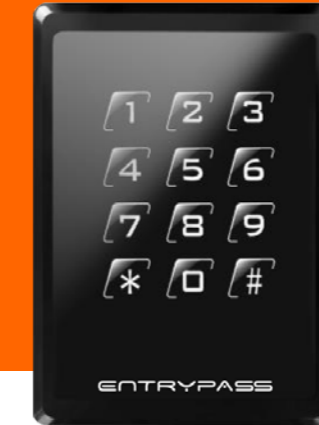

## Smart phone's App based on iOS and Android system :

- iOS® version – installed in Apple mobile phone, which required iPhone 5s model or above.
  - Android™ version – installed in Android™ mobile phone, which required version 6.0 or above.
- The smart phone's App needs to assign a card number (authorization) before it works with BT Reader.

## Modes of Access

- Show-to-Go: Show the mobile phone in front of the reader to open the door (same as swipe a card)
- Shake-to-Go: Shake the mobile phone to open the door (NOT to turn the mobile phone).
- Hands free: door opened automatically when mobile phone entered in connecting area.
- Manual Button: click the button in the APP to open the door manually.

## Security

Since Bluetooth does not carry any security element, all the communication and data stored inside the App are encrypted with AES128. The authentications as follows:

- 1st Authentication: Dynamic key is used to authenticate both Bluetooth reader and App.
- 2nd Authentication: Reader will check if the App assigned repeated Customer Code.
- 3rd Authentication: Reader will check if the App assigned repeated End User Code.

## Bluetooth Reader & Mobile Phone Apps

- Bluetooth reader supports both Bluetooth + Mifare And /Or DesFire + 125KHz technologies.
- Bluetooth reader can set different reading distance from 0.1m to 5m.
- Support IN/OUT reader configuration.
- Enter password in case of change configuration in the App, allow authorized user to configure: reading range of reader, name a reader, set different Modes of access and modes of IN/OUT reader.
- The App supports Manual Active Button when the app is running normally.
- When there is more than one reader within the reading range, all the names of readers will be popped up on the screen for user to choose which reader should be activated.
- The App shows the strength of detected Bluetooth signal.
- The App supports to run in the background mode of mobile phone.
- Supports to set a validation period of authorization.

- Read full 56 bits UID, Application & Files content of DesFire EV1 / EV2 card. Support 3DES & AES encrypted communication between the reader and card.
- Support on site Reader Configuration Card to change certain parameters.
- Number pad use "touching sensor", the latest technology and individual number backlit when touch.
- Tamper protection.
- Front plate customization and backlit design is available.
- A PIN can be set inside the card to authenticate with the reader so that "Card + PIN" mode can be implemented without relying on the controller.\*

## Features Highlight



"Touch" number pad does not carry any moving parts, which implies more durable.



Universal back plate allows the reader be installed on different size of gang box.



Reverse power protection.



All weather proof design with IP65 certificate certificate.



Non-drop bottom screw made servicing handier.



Stainless steel security screw is an option.



Metal back plate allows the reader install on metal surface and back back-to-back without affecting the read range.



All input and output signals are protected against static charges.



All inputs are 12V DC Protected.

# UNIFIED SECURITY SOLUTION

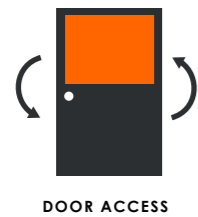

DOOR ACCESS



KEY MANAGEMENT  
SOLUTION



READ / WRITE  
APPLICATION



CCTV INTEGRATION  
MODULE



TURNSTILE &  
BARRIER GATE



LONG RANGE  
APPLICATION



BIOMETRIC  
SOLUTION



TIME  
ATTENDANCE



VISITOR  
MANAGEMENT SYSTEM



ON LINE  
GUARD TOUR



ALARM & DOOR  
STATUS MONITORING



ELEVATOR  
CONTROL



FIRE ALARM  
INTEGRATION

## TO THE FUTURE

Now that you have read through our product catalogue that has been meticulously engineered, it is time to act.

As the world moves forward into a new era of digital age, so does our need for better security. Our products in this catalogue are designed to fill in your needs and more. Whatever and whenever the market demands it, we are always ready to take up the demand.

Let's change the future.

### Malaysia

No. 40, Jalan TPP 1/10, Taman  
Industri Puchong, Batu 12 Jalan  
Puchong, 47160 Puchong  
Selangor Darul Ehsan, Malaysia.  
Tel : +603 8068 1929  
Fax : +603 8062 6937  
Email : info@entrypass.net

### Singapore

No. 1, UBI View, #03-03, Focus  
ONE Building, Singapore 408555.  
Tel : +65- 6841 7242  
Fax : +65- 6841 3937  
Email : info@entrypass.net

### Indonesia

Rukan Puri Mutiara,  
Block BF No.17, Jln Griya Utama,  
Sunter Agung, Jakarta Utara,  
14350, Indonesia.  
Tel : +62 21 2937 6098  
Email : indonesia@entrypass.net